

UTC 3414 LINEAR INTEGRATED CIRCUIT

SINGLE-SUPPLY DUAL HIGH CURRENT OPERATIONAL AMPLIFIER

DESCRIPTION

The UTC 3414 integrated circuit is a high gain, high output current, high output voltage swing dual operational amplifier capable of driving 70mA.

FEATURES

- *Single Supply
- *Operating Voltage (+3V~+15V)
- *High Output Current (70mA)
- *Slew Rate (1.0V/ μ s typ.)
- *Bipolar Technology

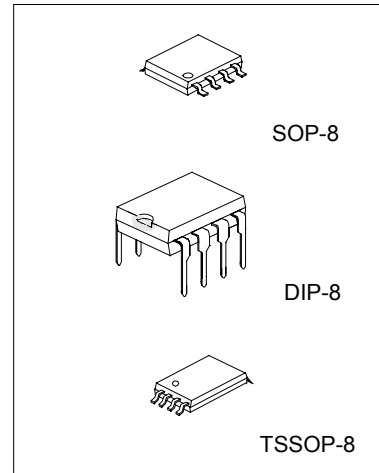

PIN CONFIGURATIONS

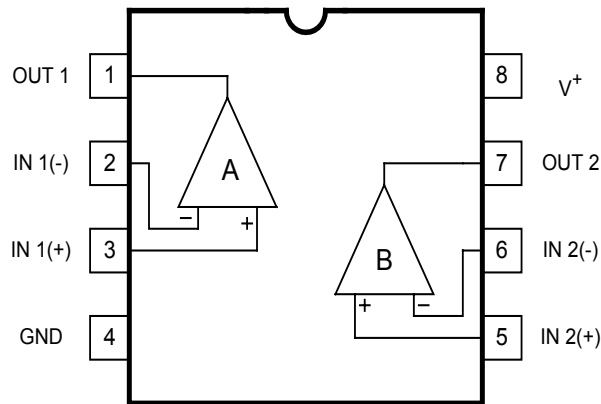

UTC3414 LINEAR INTEGRATED CIRCUIT

BLOCK DIAGRAM

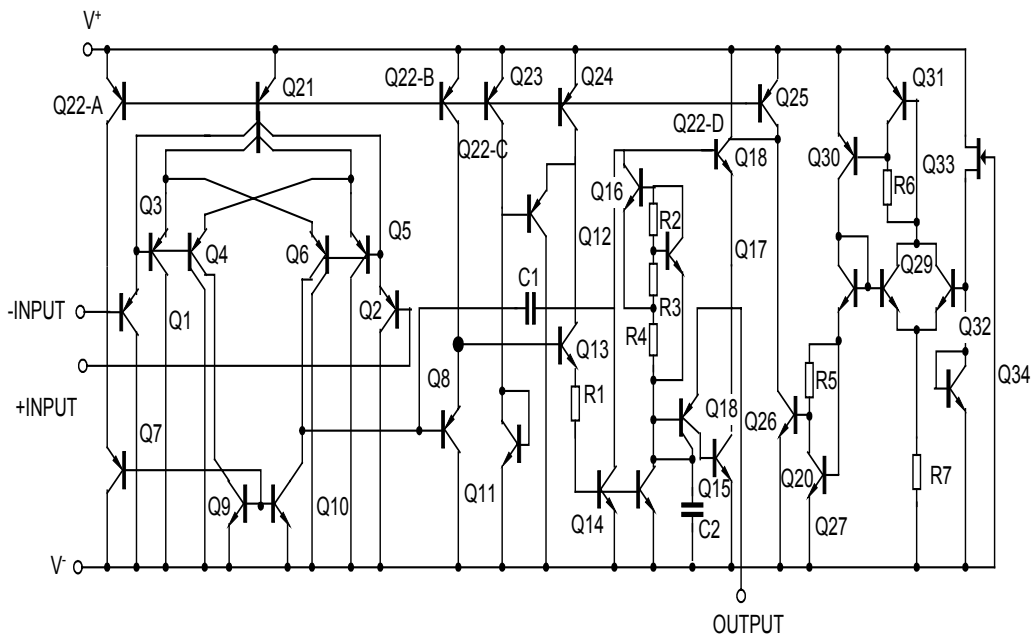

ABSOLUTE MAXIMUM RATINGS(Ta=25°C)

PARAMETER	SYMBOL	VALUE	UNIT
Supply Voltage	V+(V+/V-)	15V (or +-7.5)	V
Differential Input Voltage	V _{ID}	15	V
Input Voltage	V _I	-0.3 ~ +15	V
Power Dissipation	P _D	300	mW
Operating Temperature	T _{opr}	-20 to +75	°C
Storage Temperature	T _{stg}	-40 to +125	°C

ELECTRICAL CHARACTERISTICS(Ta=25°C, V⁺=8.6V)

PARAMETER	SYMBOL	TEST CONDITIONS	MIN	TYP	MAX	UNIT
Input Offset Voltage	V _{IO}	R _s =0Ω		2	5	mV
Input Offset Current	I _{IO}			5	100	nA
Input Bias Current	I _B			100	500	nA
Large Signal Voltage Gain	A _v	R _L =2kΩ	88	100		dB
Input Common Voltage Range	V _{ICM}		V ⁺ -2			V
Maximum Output Voltage Swing ¹	V _{OM1}	R _L >=2kΩ, V ⁺ =5V	3.5			V

UTC3414

LINEAR INTEGRATED CIRCUIT

PARAMETER	SYMBOL	TEST CONDITIONS	MIN	TYP	MAX	UNIT
Maximum Output Voltage Swing 2	VOM2	I _o =70mA, V ⁺ =5V	3.2			V
Common Mode Rejection Ratio	CMR		80	90		dB
Supply Voltage Rejection Ratio	SVR		80	90		dB
Operating Current	I _{cc}	R _L =∞	3	4	5	mA
Slew Rate	SR			1.0		V/μs
Unity Gain Bandwidth	GB			1.3		MHz
Operating Voltage Range	V ⁺				15	V

UTC3414 LINEAR INTEGRATED CIRCUIT

TYPICAL CHARACTERISTICS

Output Source Current vs. V_{sat}^+

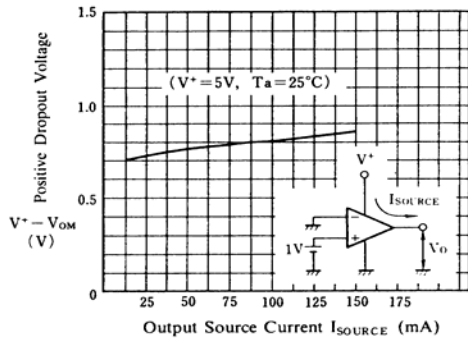

Output Sink Current vs. V_{sat}^-

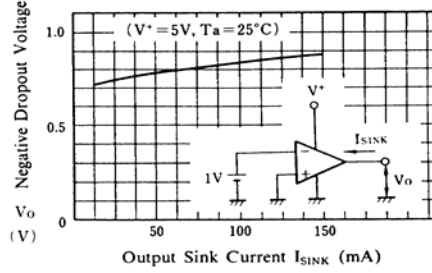

Input Offset Voltage vs. Temperature

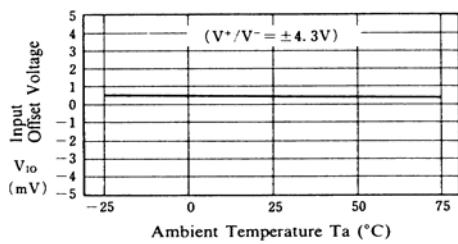

Input Bias Current vs. Temperature

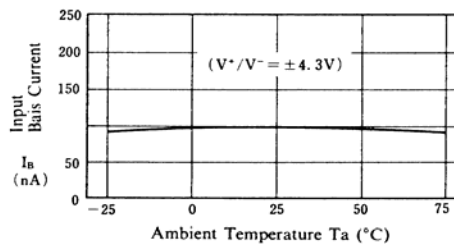

Operating Voltage vs. Operating Current

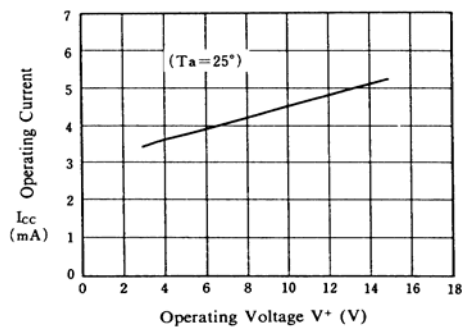

Maximum Output Voltage Swing 2 vs. Temperature

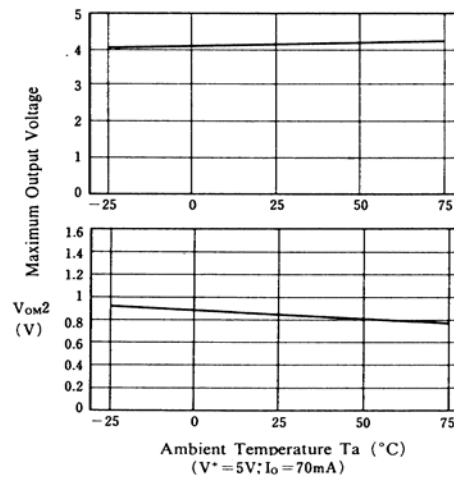

Maximum Output Voltage vs. Operating Voltage

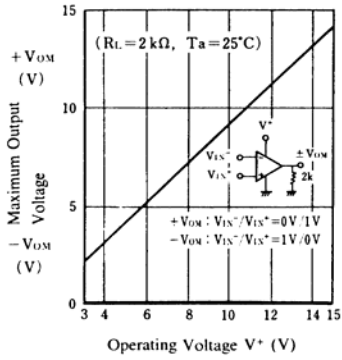

Maximum Output Voltage vs. Load Resistance

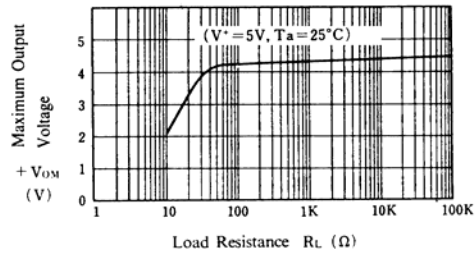

Maximum Output Voltage vs. Frequency

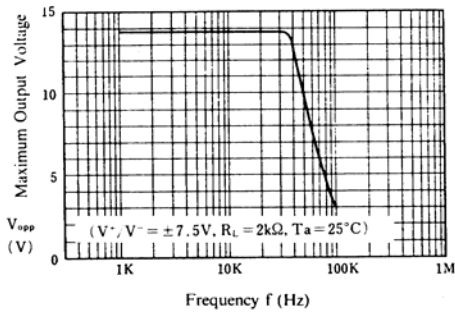

Voltage Gain, Phase vs. Frequency

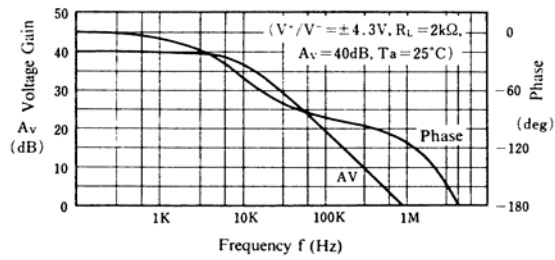

Operating Current vs. Temperature

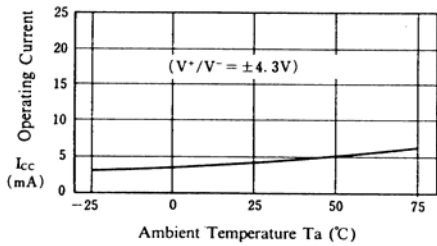

Maximum Output Voltage vs. Temperature

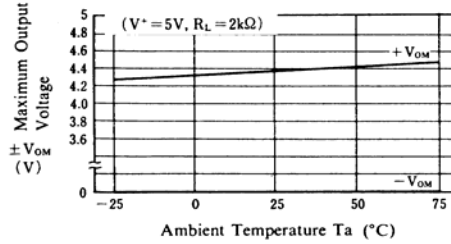

UTC3414 LINEAR INTEGRATED CIRCUIT

UTC assumes no responsibility for equipment failures that result from using products at values that exceed, even momentarily, rated values (such as maximum ratings, operating condition ranges, or other parameters) listed in products specifications of any and all UTC products described or contained herein. UTC products are not designed for use in life support appliances, devices or systems where malfunction of these products can be reasonably expected to result in personal injury. Reproduction in whole or in part is prohibited without the prior written consent of the copyright owner. The information presented in this document does not form part of any quotation or contract, is believed to be accurate and reliable and may be changed without notice.